

Programa*stat*

7 Day Digital 2 Channel Heating & Hot Water Programmer

Cat. No. TRT036



Operating & Installation Instructions



A **theben** Group Company

What is a programmer?

...an explanation for householders

Programmers allow you to set 'On' and 'Off' time periods. Some models switch the central heating and domestic hot water on and off at the same time, while others allow the domestic hot water and heating to come on and go off at different times.

Set the 'On' and 'Off' time periods to suit your own lifestyle. On some programmers you must also set whether you want the heating and hot water to run continuously, run under the chosen 'On' and 'Off' heating periods, or be permanently off.

The time on the programmer must be correct. Some types have to be adjusted in spring and autumn at the changes between Greenwich Mean Time and British Summer Time.

You may be able to temporarily adjust the heating programme, for example, 'Override', 'Advance' or 'Boost'. These are explained in the manufacturer's instructions.

The heating will not work if the room thermostat has switched the heating off. And, if you have a hot-water cylinder, the water heating will not work if the cylinder thermostat detects that the hot water has reached the correct temperature.



Certification mark

1. Introduction

TRT products are a cost effective comprehensive range of thermostats and controllers designed for internal use only.

The TRT036 is a two channel programmer dedicated to central heating and hot water, with automatic summer/winter time changeover (which can be cancelled), 5 day plus 2 or 7 (individual) day programming, pumped or gravity fed system, holiday mode, boost function, advance to next programme and permanent on/off override. There are three timed control periods per day.

The unit is fitted with a factory installed battery which gives up to 24 hours back up of time, date and programmes in the event of a mains failure.

It is designed to be surface mounted on its supplied wall plate.

The electrical supply **must** be isolated before removing the thermostat from the wall plate.

TRT036 7 Day Digital Programmer

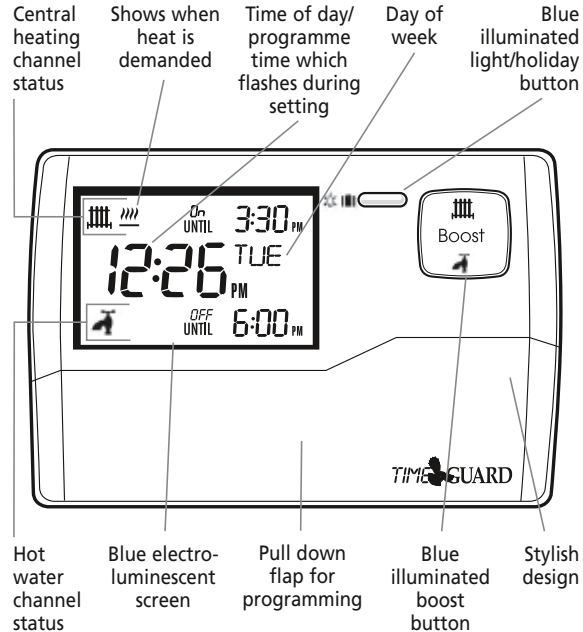

Fig. 1

TRT036 7 Day Digital Programmer

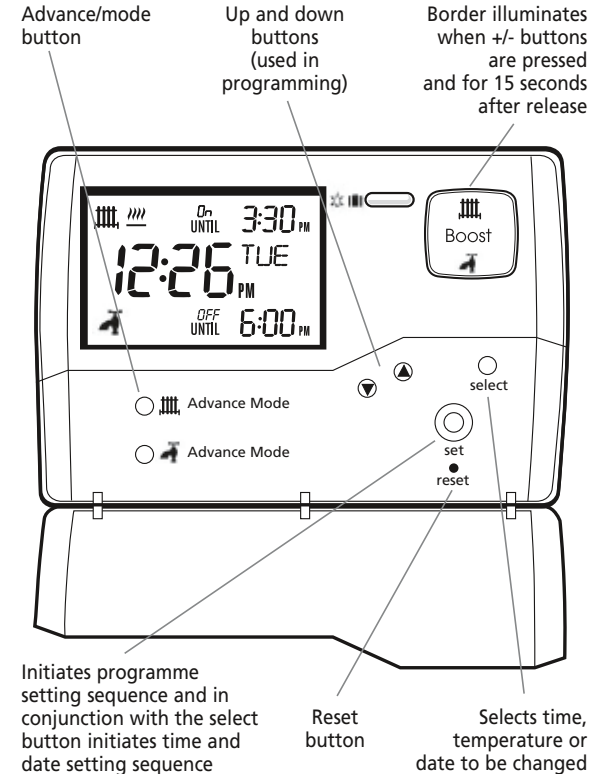

Fig. 1a

Rear View of TRT036

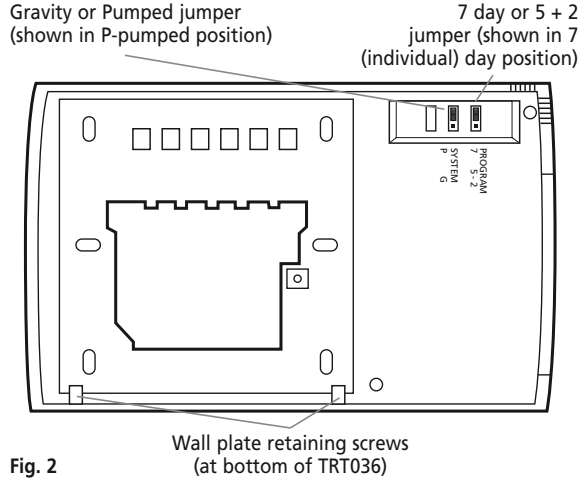

Fig. 2

Back Plate Removed

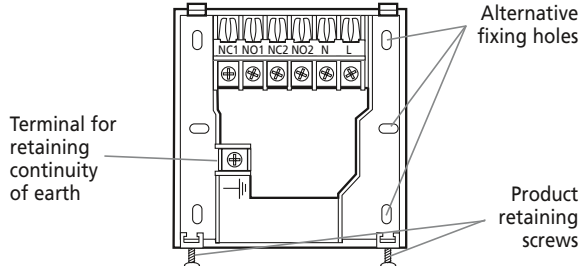

Fig. 3 Mount the wall plate in this configuration only

Contents

TRT036 programmer 2 x wall plugs
 TRT036 wall plate 2 x screws
 TRT036 instruction leaflet

2. Siting

The TRT036 should be located at a position which eases wiring runs and gives good access for programming. It should be mounted approximately 1.5m above floor level.

3. Installation

This product should be installed by a qualified installer to current installation standards. If in any doubt contact the Timeguard Helpline 020 8450 0515.

Always isolate the mains supply before removing the unit from its wall plate.

The TRT036 is designed to be surface mounted on the supplied wall plate.

Isolate 230VAC mains supply.

Incoming and outgoing cable should be 1.5mm sq.

Remove wall plate from unit, by undoing retaining screws, and pivoting the bottom of the unit outwards. The unit can then be lifted off.

Pass incoming wires through opening in wall plate, and fix wall plate securely to the wall, using screws provided. The screws which secure the product to the wall plate should point downwards.

Allow sufficient excess cable to wire up the unit, but not too much to make it difficult to close the unit to the wall plate.

Connect the conductors to the relevant terminal, according to the wiring diagram on the wall plate (or below). Ensure that the curved brass washer grips the conductor.

Wiring Diagram

Note:
 Check boiler instructions before connecting.

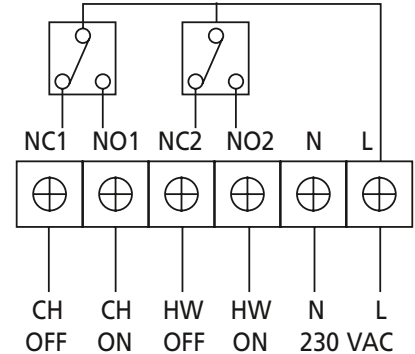

Fig. 4

This unit is double insulated, and hence does not need connection to earth. If earth continuity is required, please use earth terminal on wall plate.

To reinstall the unit on the wall plate hook the top of the unit over the retaining tabs, and push firmly back. There will be some resistance from the terminals. Once in place, secure with the retaining screws.

Restore mains to the unit after checking all system wiring is complete.

4. Operation

Decide whether weekday/weekend (5-2) or individual (7) day programming is required, and move the jumper on the rear of the product (see Fig. 2). Also move the system jumper to either G (gravity) or P (pumped) as appropriate for the system.

It is important to make these decisions first, as after any change of jumper position, reset needs to be pressed, which will return the unit to default time and programme.









Reset

When programming a new unit or one that has been disconnected from the mains for more than 24 hours, open the program access flap and press the reset button (see Fig. 1a) using a pen or similar implement which will clear the memory.

All of the screen segments will show briefly, and then the default programme will be displayed.

Setting time and date

To programme the current time and date, simultaneously press and hold both the select and set buttons for 3 seconds.

The option 12 hour or 24 hour is displayed and needs to be set. Use the up and down buttons   to select the required mode. Press select to move to setting the hours. Use the up and down buttons   to set the hour, and press select to set the minutes. Again use the up and down buttons   to set the minutes, and then select to set the year (y), the month (m), the day (d), and automatic summer/winter time change or daylight saving (dls) on/off, in each case using the up and down buttons  . Once the time and date have been set, press set to exit back to the operating mode.

If at any time a button is not pressed for 15 seconds, the unit will return to operating mode.

Individual (7 day) programming on/off times



The default on/off times for heating and hot water are as follows:



6:00 AM	on
8:00 AM	off
10:00 PM	on
12:00 PM	off
6:00 PM	on
10:00 PM	off



These apply to every day independent of whether weekday/weekend (5-2) or individual (7) day option is chosen.



Note: to omit days and programmes please refer to “Omitting days and programmes”



To change from default values, proceed as follows:-





Press set and MON will flash (with programme (P) 1 on time for heating  displayed). Press select and P1 on hour digit(s) will flash, use   buttons to get the required hours.





Press select and P1 on minute digits will flash, use   buttons to get the required minutes.

Press select and P1 off hour digit(s) will flash, use   buttons to get the required hours.



Press select and P1 off minute digits will flash, use   buttons to get the required minutes.

Press select and programme (P) 2 on hour digit(s) will flash, use   buttons to get the required hours.

Press select and programme (P) 2 on minute digits will flash, use   buttons to get the required minutes. This procedure of alternatively using select and   can be continued to set programmes P2 and P3.

Once complete the programmes for hot water  on Monday can be started by pressing the set button when MON will begin to flash and the hot water  symbol will be displayed. Press the   buttons

to get to the required day for programming, then press select and the hot water can be programmed as the heating above.

Having done this, heat and hot water programmes for Tuesday can be started by pressing the set button and selecting TUES heating using the   buttons.

The three on periods for heating and hot water can be programmed as for Monday.

Complete all 7 days in the same manner. If set is then pressed twice the TRT036 will return to operating mode.

This defaults to continuously off – refer to “Setting the operating mode” to get into timed mode.

Weekday/weekend (5-2) programming on/off times

For 5-2 day mode, time periods will need to be programmed for M-F (Mon-Fri) and then for S-S (Sat-Sun). Only 2 sets of times need to be programmed, not 7.

Setting the operating mode

Coming out of programming, the default mode is ‘continuously off’. To enter set operating mode, press the advance/mode button. One press changes the output to ‘continuously on’, two presses changes to ‘programmed’, and three presses changes to ‘advance to next programme’. In advance mode, once the next time period has past, the programmer returns to programmed mode.

Omitting days and programmes

Days can be omitted by entering the same time in each of the 3 on/off programmes for that day.



In 5-2 day mode the weekend can be omitted by using the same technique for the 2 day (Sat & Sun) programmes.

A programme (usually P2) can also be omitted for a given day by making the P2 on and off times the same. This can also be applied to P1 and P3 if required.

Boost

In operating mode, there is a boost facility for between 1 and 9 hours in one hour steps. Press the boost button the required number of times for the number of hours of boost required.

The programmer returns to operating mode 15 seconds after the last button push. To cancel boost, press the boost button until 0 hrs is shown.

Press and hold the light  button and the programmer will enter **holiday mode**. Use the   buttons to set the required number of days. The programmer will return to operating mode 15 seconds after the last button push. To exit holiday mode, press and hold the light button again.

Screen illumination

Press the light button  briefly at anytime, and the screen will illuminate for 15 seconds.

To clean use a clean dry cloth only. Do not use any liquid cleaners.

Gravity System

Although the hot water may be programmed to come on at different times to the heating, by the nature of the system, it will also come on during all the on times programmed for heating. This will also be true when in boost or advanced modes.

5. Specifications

Current rating: 3 (1) A

Voltage: 230V, 50Hz

Switch type: Single pole, double throw (SPDT) for both heating and hot water

Operating temperature range: 0°C to 50°C

Complies with: BS EN 60730

Conforms to directives: Conforms to latest directives

Micro disconnection: Type 1.B control action

For assistance with the product please contact:-

HELPLINE

020 8450 0515

or email helpline@timeguard.com



3 Year Guarantee

In the unlikely event of this product becoming faulty due to defective material or manufacture within 3 years of the date of purchase, please return it to your supplier in the first year with proof of purchase and it will be replaced free of charge. For years 2 and 3 or any difficulty in the first year telephone the helpline on **020 8450 0515**.

Note: a proof of purchase is required in all cases. For all eligible replacements (where agreed by Timeguard Ltd) the customer is responsible for all shipping/postage charges for sending replacements outside the UK.

All shipping costs are to be paid in advance before a replacement is sent.

For a product brochure please contact:

Timeguard Ltd. Victory Park, 400 Edgware Road,
London NW2 6ND Tel: 020 8452 1112

or email csc@timeguard.com

A **theben** Group company

67-058-327 (issue 2)