

GuardCam^{WF}

Wire free external area protection system



Installation and operation manual

GuardCam WF-SAR • GuardCam WF-T • GuardCam WF-MR



Table of contents

System components	4
Introduction	5
GuardCam WF-T	6
GuardCam WF-SAR	6
GuardCam WF-MR	7
GuardCam WF-T Installation	8
PIR Set Up	9
System Set Up	10
System Setup	14
Captured Image Playback Software	17
Connecting to a Television	21
Trouble Shooting Guide	22
Best Practice	23
Technical Specifications	24

System components



GuardCam WF-T
Combined PIR Floodlight camera and transmitter



GuardCam WF-MR
Combined Monitor receiver



GuardCam WF-SAR
Stand alone receiver module

Introduction

The GuardCam-WF range of products are an ideal solution for the protection of external areas around domestic or light commercial properties. Images are captured by wire free cctv cameras built into pir controlled security lighting units and digitally transmitted to a choice of receivers with integral SD card recording. GuardCam operates on a secure stable 2.4ghz frequency to provide excellent range and image quality. The feature packed yet user friendly control interface provides a number of useful options. To obtain the most from your GuardCam-WF installation please read through this manual carefully.

Getting the best from Wire free technology

Whilst employing the benefits of latest digital signal technology a number of key factors should be remembered when siting both transmitter and receiver units. Think of the wire free signal travelling as a straight line between transmitter and receiver –“ The line of transmission”.

The stated Open field range of 150M is exactly that , across an open field. Any line of transmission obstruction will reduce the useful range.

When siting units consider minimising the number of walls, trees, doors, hills within landscaping or other solid objects that exist along the line of transmission.

Avoid a line of transmission that follows the whole length of a wall rather than directly through it. A small adjustment to the position of either transmitter or receiver can make a huge difference to performance .

Avoid siting transmitter or receiver units in close proximity to other wire free equipment such as routers, baby monitors or sources of electrical energy such as microwave ovens, very high voltage cable etc.

Following these guidelines will achieve the best results from a given site. The construction method of obstructions will create variance in results however a satisfactory system should be achievable on most buildings up to 4000 sq meters.

System architecture

Up to four transmitters (GuardCam WF-T) can be paired with a single receiver (either GuardCam WF-MR or GuardCam WF-SAR).



Note. A transmitter can only be paired with one receiver at a time. It is not possible to pair a single transmitter with two separate receivers.

GuardCam WF-T



GuardCam WF-SAR

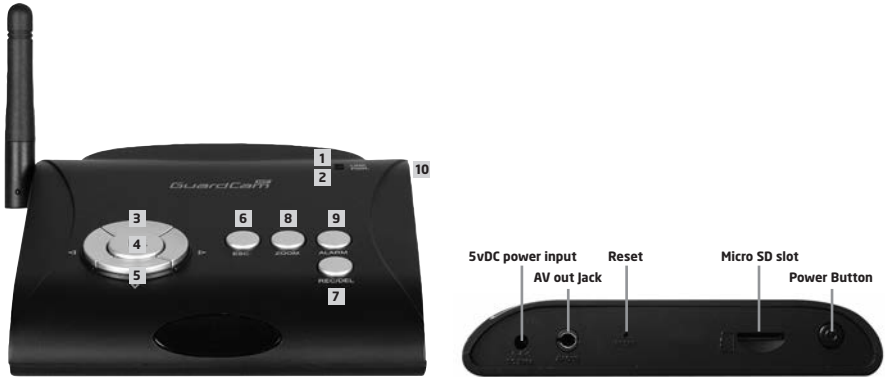

	DISPLAY	MENU	PLAYBACK	REC MODE	OTHER
1					Link indicator
2					Power indicator
3	Switch Channel	Cursor UP	Fast Forward		
4	Menu	OK / ENTER	PLAY / PAUSE		
5	Switch Channel	Cursor Down	Fast Backward		
6	ESC	EXIT	Previous		
7	REC/STOP		DEL	STOP	
8	ZOOM		Next		
9	ALARM				
10					Power Button

GuardCam WF-MR

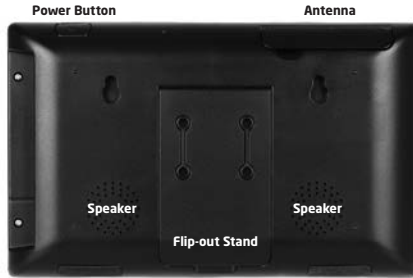

	DISPLAY	MENU	PLAYBACK	REC MODE	OTHER
1					Link indicator
2					Power indicator
3	Channel up	Cursor UP	Fast Forward		
4		menu Left	Switch Display CH		
5	Menu	OK / ENTER	PLAY / PAUSE		
6		menu Right	Switch Display CH		
7	Channel down	menu Down	Fast Backward		
8		EXIT	Previous		
9			Next	Start/STOP	
10	ZOOM				
11					Alarm on/off
12					Power Button

On screen Icons

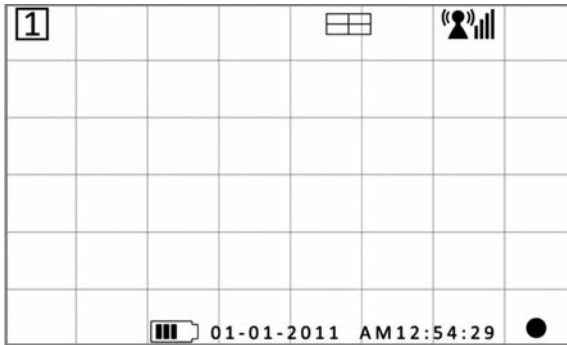

General

- Channel Indicator
- Signal Indicator
- Recording Indicator (Red Flashing)

Display mode

- Quad Display
- Scan Display
- Single Display

Battery Power Indicator

- 100% Strength
- 70% Strength
- 50% Strength
- 20% Strength

GuardCam WF-T Installation

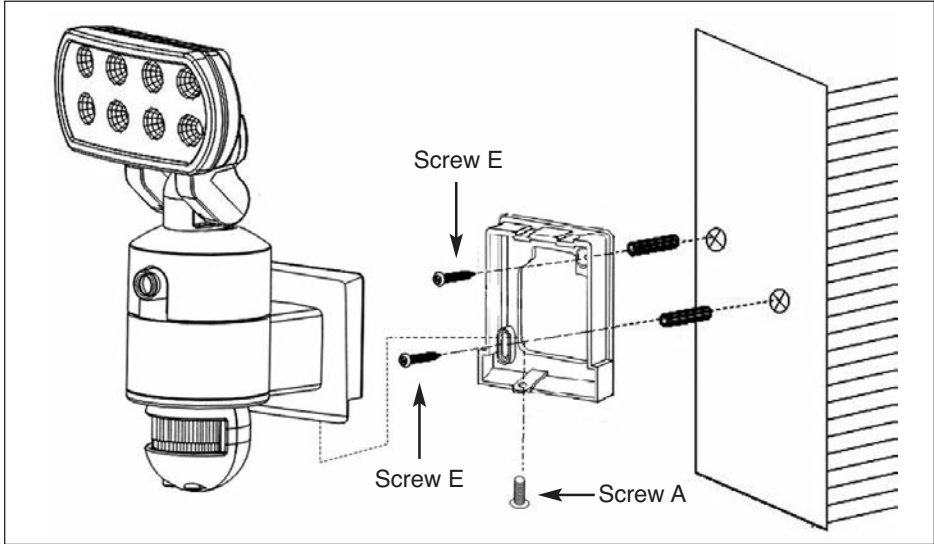

1. Place plastic masonry plugs into desired surface aligning holes as shown above. Using an electric screwdriver, fasten mounting plate directly to surface using screws E.
2. Feed the cable through the back mounting box and bush the cable entry to avoid abrasion to the cable.
3. Wire the unit as follows: (Ensure all wires are connected securely and that no loose strands are exposed)

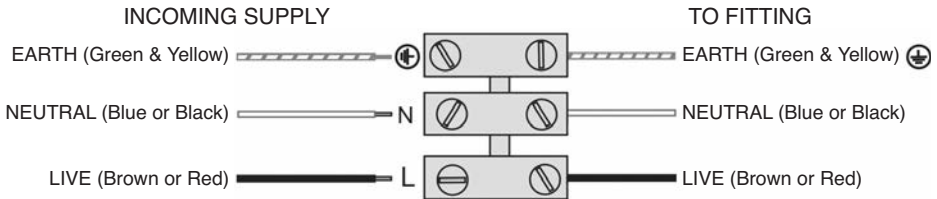

4. Make sure the polarity is correct. Double check the connections after wiring. Errors may damage the motion sensor or cause a fire hazard.
5. Attach the unit to the mounting plate. You will first need to angle the unit back so that the catch at the top of the mounting plate fits into slot on the back of the unit. Next lower the unit until holes at the bottom of the mounting plate and unit are flush. Then screw (screw A) into this hole, tightening carefully.

PIR Set Up

For optimum performance it is recommended to mount the GuardCam WF-T 1.8 to 2.5 m above the ground. The PIR has a range of 12m over a 140 degree angle.

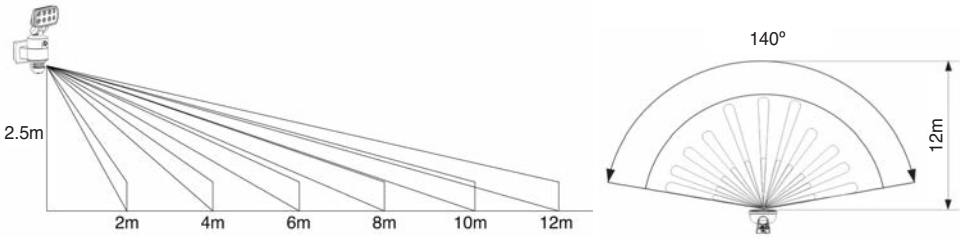

PIR technology provides much better target capture if movement is across the face of the PIR. Aim the PIR to achieve the highest chance of this happening.

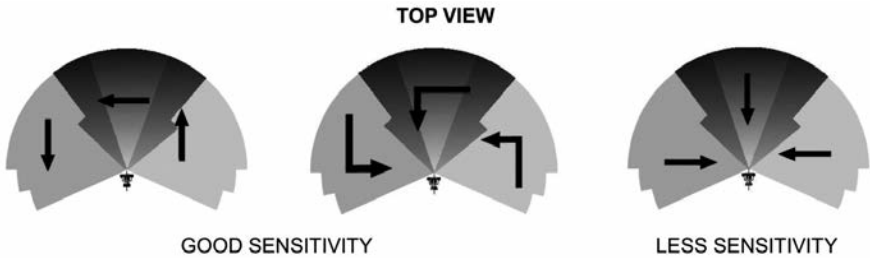

Setting the Time and Lux control

- **Time control:** The time the floodlight is illuminated after triggering can be set between 30 seconds to 7 minutes. Turning the dial clockwise will increase the time, turning counter-clockwise will reduce the time.
- **Lux control:** PIR activation of the floodlight is also controlled by a photocell to ensure illumination only occurs when required. Adjustment can be set between darkness, fully clockwise and daylight (walktest), fully anti clockwise.
- To perform a walk test turn the dial fully anti clockwise. When the walk test is completed adjust the dial clockwise to the "+" side to your desired light on time (we recommend this be at least 2 minutes to ensure lighting of the area is sufficient for the minimum recording time).

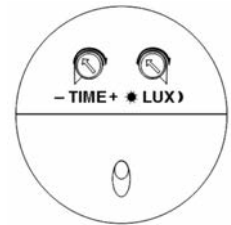

System Set Up

Before commencing system configuration ensure all GuardCam WF -T units to be included in the system are powered and a clean formatted mini SD card is present in the chosen GuardCam WF receiver.

Please also ensure the chosen GuardCam RF receiver is powered using the supplied 5VDC plug in power supply.

Important. Only use the plug in power supply provided with the unit. Use of other power supplies may damage the unit and invalidate the warranty.

Note. It is not possible to enter the set up menu if a recording session is occurring. It is possible to stop recording by pressing Rec/Del.



Main Menu

- Press the MENU button to enter the MAIN MENU. The system highlights EVENT LIST by default.
- Use ▲▼◀▶ to navigate through the menus; press the MENU button to confirm selection and enter sub-menu.



Camera Setup

- Select CAMERA SETUP, press the MENU button to enter sub-menu.
- Use ▲▼ to select the camera to set up (camera 1-4).
- Use ◀▶ to select the sub-menu

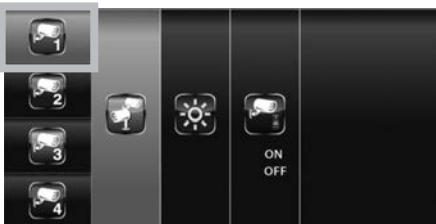

Pair a new device (GuardCam WF-T)

Pairing GuardCam WF-T to a Receiver

- Pairing allows the GuardCam WF-T to communicate with a chosen receiver (GuardCam WF-MR or GuardCam WF-SAR).
- Up to four GuardCam WF-T transmitters can be paired with each receiver.
- A GuardCam WF-T can only be paired to a single receiver at any one time.
- Pairing to a second receiver will delete the pairing with the initial receiver.
- The GuardCam WF-T pairing button is located to the rear of the floodlight.
- Pair each GuardCam WF-T individually to a separate channel.
- With the PAIRING option highlighted, press the menu / select button once to begin camera pairing.
- Press and release the pairing button on the GuardCam WF-T twice. The System will confirm pairing process to be successful by displaying "PAIRED" on screen.



Image brightness adjustment

- Press ▼▲ to select a camera for adjustment.
- Press ▼▲ to select brightness level.
- Press ESC to return to MAIN MENU or press ▼▲ to select another camera.



Camera Activation

It is possible to turn cameras on or off. Please turn cameras to off position if channel has no camera paired.

- Press ▼▲ to select a camera for adjustment.
- Press ▼▲ camera on or off.
- Press ESC to return to MAIN MENU or press ▼▲ to select another camera.



Record Setup

- From main menu select record setup icon, press the MENU button to enter sub-menu.
- Use ▼▲ to select the required sub menu.



Record mode selection

- It is possible to select a specific recording style for each hour of the day or generally for the whole day.

Note : all channels are effected by selection made

M-Motion Only record when on movement is visible on screen

S-Schedule Always record at all times

X-Manual Select a record style for each time of day

- Use ◀▶ to select the recording style
- If X-Manual is selected use ◀▶ and ▼▲ to select each hour of the day then press menu to toggle through the record options (Manual , Schedule, Motion) for the selected hour.

Note : A recording cannot be stopped until 30 seconds after the start of a recording by any method.

- To manually stop recording, press REC/DEL on the front panel.
- Menu control functions are disabled while system is recording.

NB . A manual recording can be activated in any mode by pressing the Rec/Del button.



Motion Detection Sensitivity

Motion detection sensitivity can be selected on each camera from highest sensitivity to off. This can be useful when motion detection recording mode is selected for the whole system but only certain cameras are required to make a motion record trigger.

- Use ▼▲ to select motion detection sensitivity section
- Use ◀▶ to highlight camera for setup
- Use ▼▲ to adjust sensitivity level
- Press ESC to save and exit.



Setup Masking Area

Specific sections within the viewed area can be masked to avoid false or repetitive triggering by motion detection.

- Use ▼▲ to select SETUP MASKING AREA section.
- Use ◀▶ to highlight camera for setup, press MENU to enter.
- Use ▲▼◀▶ to highlight the grid for motion detection area. Use the MENU button to mask/unmask within the grid. Movements taking place inside the masked area will be ignored.
- Use ▲▼◀▶ to select another grid for setup or press ESC to save and exit.

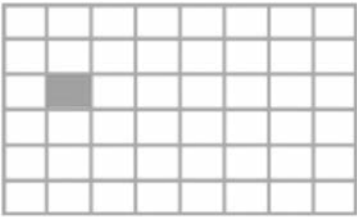

Record Time

The length of record time following a motion trigger can be selected between three options. 2 minutes, 5 minutes or 10 minutes.

- Use ▼▲ to select RECORD TIME section.
- Use ◀▶ to highlight recording period: 2 Min / 5 Min / 10 Min, press the MENU button to confirm.
- Press ESC to save and exit.



Event List

Playback

- Select EVENT LIST, press the main menu to enter sub-menu.
- Use ◀▶ to highlight desired DATE index for playback. Press MENU to confirm selection and enter selected folder.

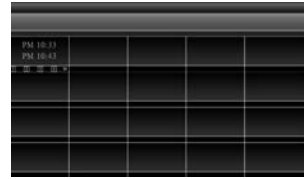
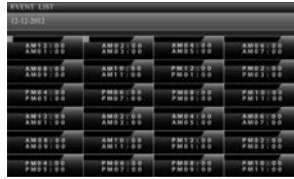
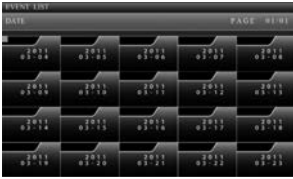

■ Press ◀▶ to select Hour (each block represents one hour time). Press MENU to enter.

■ Use ◀▶ to highlight desired HOUR for playback. Press MENU to confirm selection and enter selected folder.

NOTE: Each RECORDED FILE folder indicated with file start / end time and type of file recorded.

Starting / Time

The type of recorded file (Schedule / Motion / Manual) is indicated.



Start Time = PM10:33
End Time = PM10:43

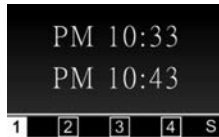

Channel 1 is SCHEDULE recorded file

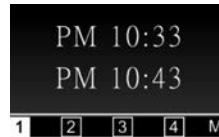

Channel 1 is MOTION recorded file

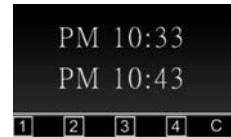

Channel 1, 2, 3 and 4 are MANUAL recorded files

To playback recorded file, use ◀▶ to highlight RECORDED FILE. Press MENU to confirm selection and playback selected file.

NOTE: By default, playback display will be QUAD (displaying images of all cameras paired to receiver).

■ 1 2 3 4 = All channel playback

For single camera display, press MENU once after playback started to PAUSE.

Use ◀▶ to select from channel to channel.

Channel indicator (bottom left screen) will indicate the channel number selected.

- 1 2 3 4 = Channel 1 playback in full screen
- 1 2 3 4 = Channel 2 playback in full screen
- 1 2 3 4 = Channel 3 playback in full screen
- 1 2 3 4 = Channel 4 playback in full screen

System Setup

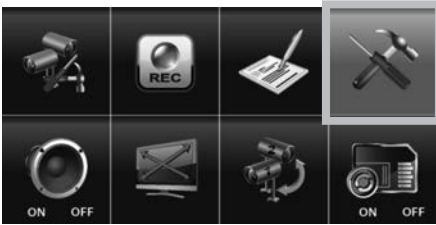

- Select to set up the general configuration of the system.
- Select SYSTEM SETUP, press the MENU button to enter sub-menu.
- Use ▼▲ to select the sub menu



Date and Time

- Use ▲▼ to highlight DATE AND TIME, press MENU to enter.
- Use ◀▶ to highlight adjust: YEAR / MONTH / DATE / HOUR / MINUTE, use ▲▼ to adjust each section and press MENU to confirm adjustment.
- Press ESC to save and exit.

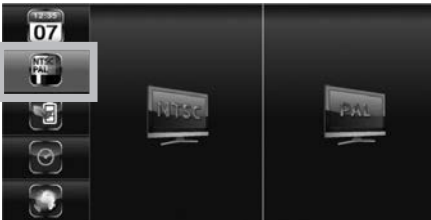

TV Output

Adjusts the TV output protocol between PAL and NTSC

- NB Ensure PAL is selected for use in the UK.
- Use ◀▶ to highlight NTSC or PAL, press MENU to confirm selection.
- Press ESC to save and exit.



Power Saving

After a preset time following no button or menu selection the system can automatically switch off the monitor (only when using GuardCam W/F -MR) to save energy and preserve screen life.

- Use ◀▶ to select SCREEN OFF AFTER 5 MINUTES / SCREEN OFF AFTER 10 MINUTES IDLE / SCREEN ALWAYS ON, press MENU to confirm setting.
- Press ESC to save and exit.

NOTE: POWER SAVING is for GuardCam W/F-MR ONLY.

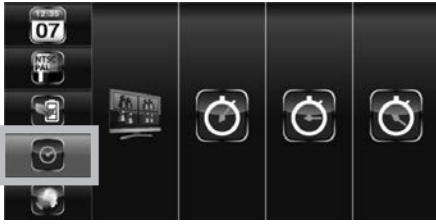

Multi Channels Idle Display

Selects style of display after no inputs received or selections made for 3 minutes .

- Use ◀▶ to select:
 - DISPLAY QUAD(all images) after idle period
 - Display each channel at 5 SEC intervals
 - Display each channel at 10 SEC intervals
 - Display each channel at 15 SEC intervals
- Press MENU to confirm selection
- Press ESC to save and exit



Display QUAD mode



Display each channel at 5 sec Intervals



Display each channel at 10 sec Intervals



Display each channel at 15 sec Intervals

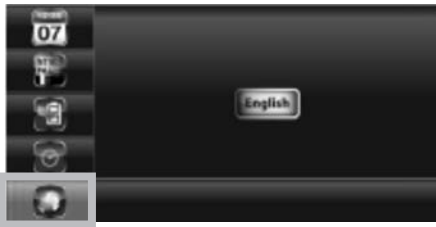

Default

- Use ◀▶ to select the system language for SYSTEM RESTORE.
- Press MENU to confirm selection and system will restore to factory default.
- A. Camera Setup
 - CH1=ON CH2=ON CH3=OFF CH4=OFF
 - Brightness= level 2
- B. Recorder Setup
 - X = Manual REC
 - Motion detection sensitivity = level 2
 - Masking area = all activated
 - REC time = 2 minutes
- C. System Setup
 - Time = 2013 01 01
 - Power Save = OFF
 - Idle display = Quad
- D. Alarm = OFF
- E. SD Card Overwrite = OFF

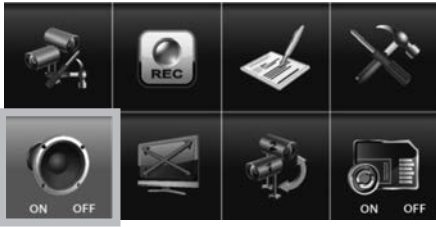

Alarm Buzzer

- Select on/off for alarm sound on activation of motion detection on any camera .
- Select ALARM BUZZER, press the MENU button to turn buzzer ON or OFF.

Note: The SD card must be inserted and have sufficient space for the alarm to operate. Alarm can also be switched on and off at front panel

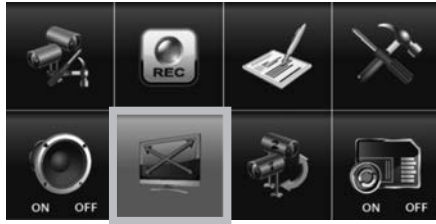

Pan, Tilt, Zoom

Allows user to zoom image by 2x and then move around the zoomed image in the horizontal and vertical plane.

- Select PAN TILT ZOOM, press the MENU button to enter ZOOM mode, press MENU again to zoom in (2X).
- When zoomed in, use ▲▼◀▶ to select various view areas. Press MENU to zoom out. In zoom out (1X), use ▲▼ to change available channel. Press ESC to exit ZOOM.

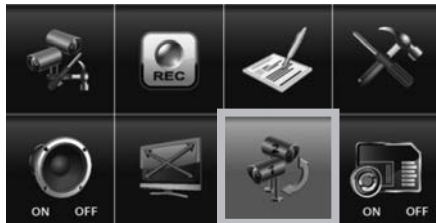

Scan Activated Cameras

Used to check which cameras are paired to the system and switched on.

- Select SCAN ACTIVATED CAMERAS, press MENU once to begin camera scan mode.

Note: System will automatically activate QUAD display if recording function is activated.

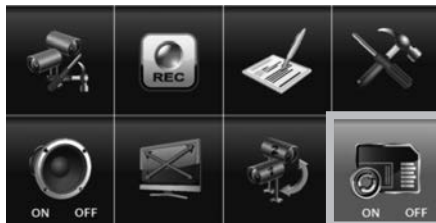

Memory Card Overwrite

When memory card overwrite is selected the system will record over the oldest recorded file when the SD card is full

- Select MEMORY CARD OVERWRITE, press MENU to activate overwrite function and press MENU again to deactivate.

Note: One of the following examples will appear on MAIN MENU.

- (1) Available capacity on memory card.
- (2) ERROR - either memory card is missing, locked or damaged.

If the overwrite function is not selected the system will display "MEMORY FULL PLEASE FORMAT" on preview screen when the SD card is full. Please be sure to backup the data if required to an alternative storage device before formatting the memory card.

Captured Image Playback Software

Images captured by GuardCam-WF can be transferred to PC for storage and transfer. To increase the security of these images they are encoded in .snx format. Playback and control of .snx files is possible via the Sec24 Media Player included on the CD provided with your GuardCam-WF. Files are physically transferred from GuardCam-WFs micro SD card using the included MicroSD - SD coverter and SD - USB adaptor.

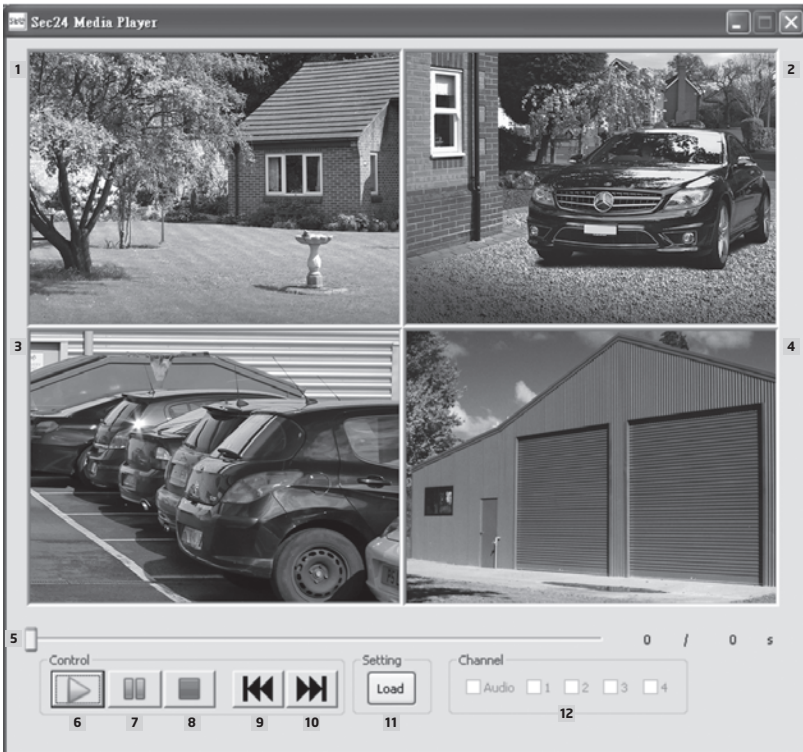

- | | | |
|------------------------------|--------------------------|-------------------------------------|
| 1. Channel 1 Playback Screen | 5. Playback Progress Bar | 9. Fast Rewind |
| 2. Channel 2 Playback Screen | 6. Play | 10. Fast Forward |
| 3. Channel 3 Playback Screen | 7. Pause | 11. Load Recorded File(s) |
| 4. Channel 4 Playback Screen | 8. Stop | 12. Channel Enable / Disable Select |

Software Installation

Insert the CD into the CD-ROM of the PC.

Click on MY COMPUTER, double click on the drive where the CD-ROM is assigned by the PC (for example: E:\) and you will find the Sec24 Media Player icon. Please read the following steps to complete installation.



Sec24 Media Player icon

- If Window 7 is running on your PC, please right click on icon “Sec24 Media Player” and select “Run as administrator” option first to begin installation.

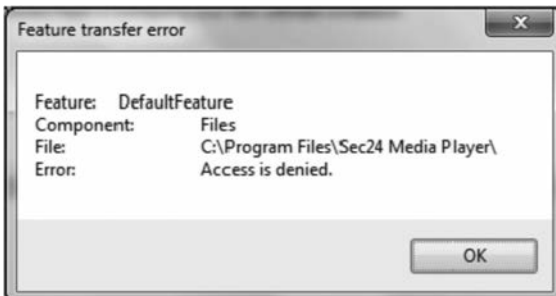
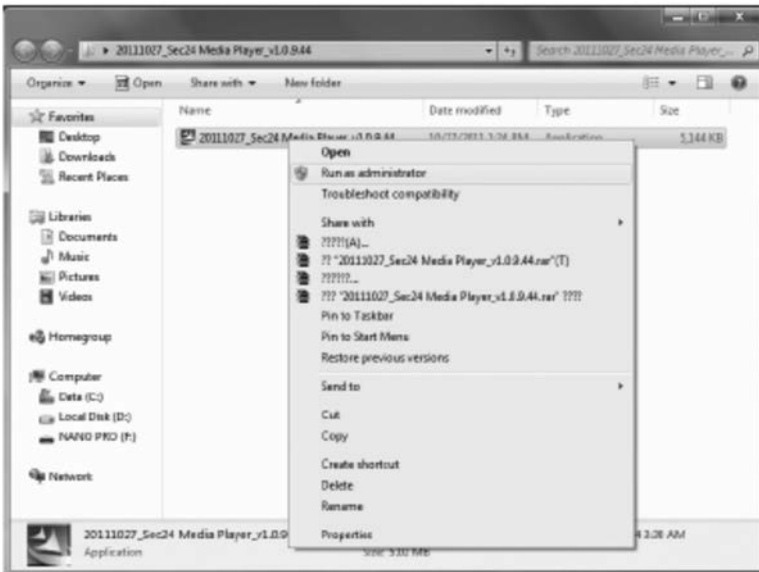

Note: The following error message will appear if you did not select “Run as administrator” option first before starting the installation.

- Double click the icon to start the installation process.
- Click "Next" to continue the installation.
- When the installation is completed, click "Finish" to exit the install wizard.

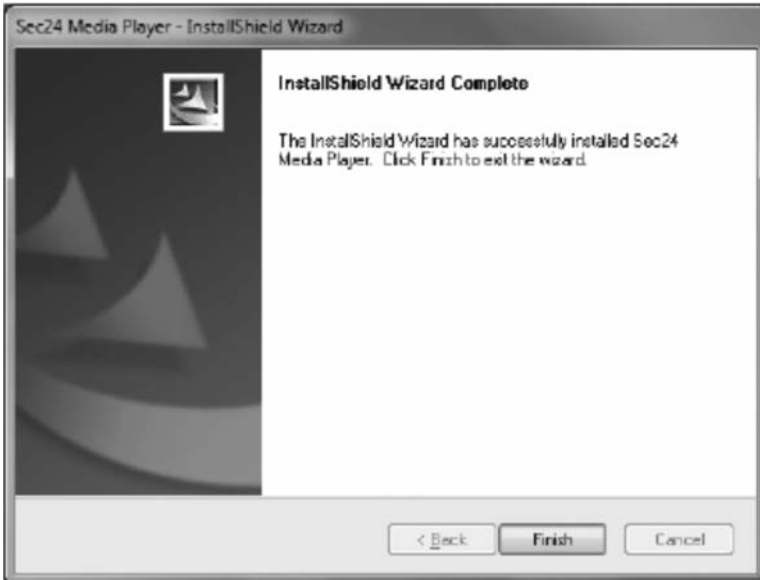

Playback Recorded File(s)



- Double click the Sec24 Media Player icon on the desktop to start the software.

Sec24 Media Player icon



- Click on "Load" to import and playback previous recorded files (.SNX files) already stored on your PC.

Note: You will first need to save the files from the Micro SD card to the PC first. Using the supplied SD-USB adapter.

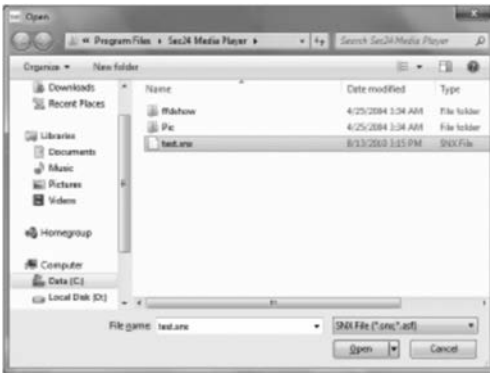

During playback, all four channels can playback at once.

Select 1 to playback video image from channel 1

Select 2 to playback video image from channel 2

Select 3 to playback video image from channel 3

Select 4 to playback video image from channel 4

When more then one channel selected for playback, system will display playback screen in QUAD format.

Please note that if you wish to distribute .SNX files the PC used for viewing must also load the enclosed sec24 media player software.

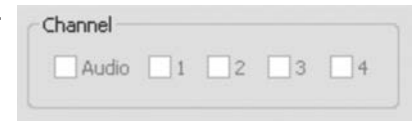

Connecting to a Television

Both GuardCam WF receivers can be directly connected to a television with AV inputs to display live images or menu controls. An AV lead is supplied for this purpose.

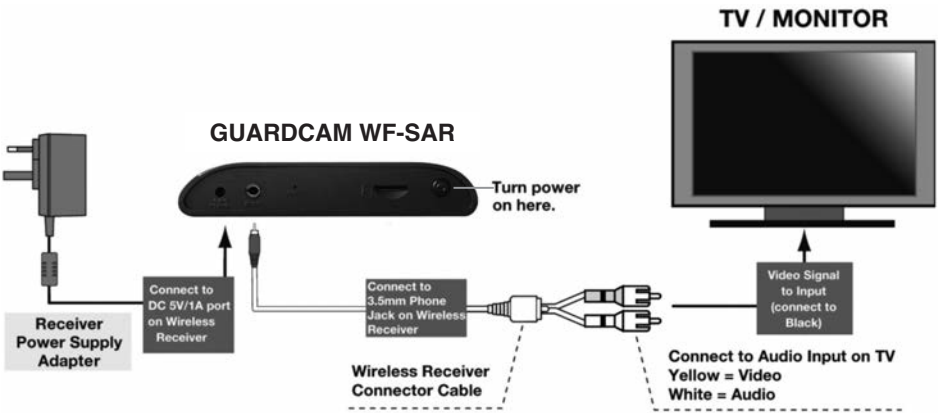
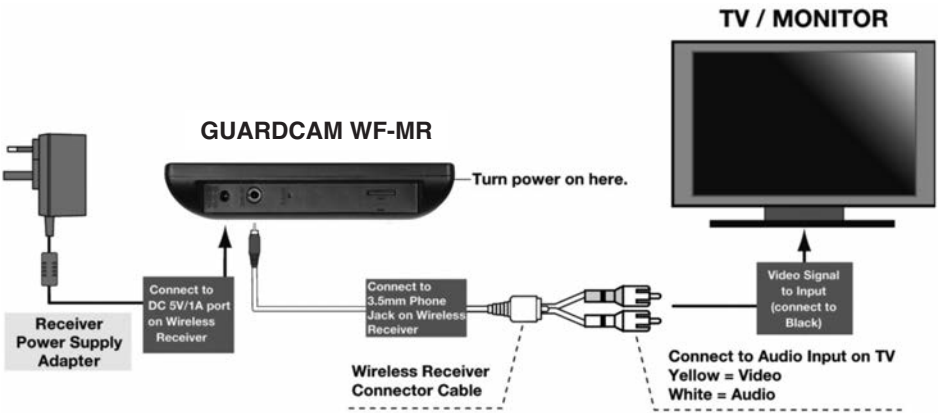

Trouble Shooting Guide

Problem	Solution
No image appears	<ul style="list-style-type: none"> • Make sure the power adaptor is not damaged or defective and is plugged into an electrical outlet with power. • Make sure the receiver has enough charge • Make sure the GuardCam-WF-T is powered. • Relocate the camera/receiver to obtain the best reception for wireless signals. • Make sure the camera is properly paired to the receiver. • Make sure your paired transmitter is not located on another channel. • Press the Menu button on the receiver to exit the system idle mode and go back to the main screen.
Low wireless signal or Low frame rate	<ul style="list-style-type: none"> • Other wireless devices may reduce the signal strength. • Leave as much space as possible between the transmitter(s)/receiver and wireless devices. • Flip the antenna of the receiver to obtain the best reception from the GuardCam WF-T units.
Poor picture quality	<ul style="list-style-type: none"> • Move the GuardCam WF-T(s) and receiver closer to ensure the appropriate wireless range. • Remove the obstacles between the camera(s) and receiver. • Clean the camera lens using lens cleaning cloth. Spots or dust on the lens can also cause image quality issues.
Motion detection not working	<ul style="list-style-type: none"> • Confirm the motion detection has been correctly set up or scheduled. • Adjust the sensitivity of the motion sensor.
The recording doesn't work as scheduled.	<ul style="list-style-type: none"> • Make sure correct DATE AND TIME has been correctly set. • Make sure the Record Schedule has been setup correctly. • Make sure the memory card is inserted and formatted. • In motion detection mode, a moving object within the camera viewing angle is necessary to trigger the motion sensor for recording.
Unable to pair the camera to the receiver	<ul style="list-style-type: none"> • Make sure the camera and the receiver are powered on. • Press and release the pairing button on the camera. • Power off the receiver and restart. If power button does not work, use a pin to press the reset button on the side of the receiver.
Memory card error	<ul style="list-style-type: none"> • Make sure the memory card is correctly inserted and formatted.
Wrong data and/or time is shown.	<ul style="list-style-type: none"> • Wrong date and/or time will result in unexpected record schedule. Please configure correct system date/time. Please note Time and date settings will be lost if the receiver loses power .
More cameras are added but not all of them show images on the receiver	<ul style="list-style-type: none"> • Make sure all cameras are properly paired. • Make sure all cameras are properly activated. • Follow the solution of 'No image appears'.

Best Practice

- Please consider the following points to achieve best performance from your GuardCam WF system.
- Before inserting an SD card for the first time and each time it is re-inserted it's a good idea to format the card using a PC or Laptop.

To format the SD card

Ensure to save any required images to an alternative folder prior to formatting.

- Place it in the SD / USB adaptor supplied
- Place the adaptor in a spare USB port on your PC / Laptop
- Right click on the SD card location
- Select Format
- Ensure the correct file system is selected FAT16 (or FAT) for SD and FAT32 for SDHC
- Ensure the Quick Format option is NOT selected
- Select "Start"

Following these simple points will ensure correct operation of GuardCam WF and should be considered as part of its maintenance schedule.

- Bear in mind that time and date settings should be checked on the GuardCam WF receivers if the units may have been left without power. If power has been removed from the receiver and / or battery power has been lost stored images will retain the correct time and date stamp however time and date settings will need to be corrected before starting further recording sessions.
- GuardCam WF-T transmitter units should not be mounted lower than 1.8m to achieve best detection range and avoid unwanted attention.
- Use the built in motion detection masking facility to avoid false triggering of recordings in areas where recording is not required.
- Regularly clean the camera and PIR lens of the GuardCam WF-T with a soft dry cloth.
- Avoid locating GuardCam WF receivers in close proximity to sources of electrical energy or wire free transmissions.
- Carefully consider the line of transmission between the location of transmitters and receivers. Try to avoid locations where the line will travel along the length of a wall or other solid object rather than directly through it.

Technical Specifications

GuardCam WF-T

Detection Method	Passive Infrared
Sensor Range	12m x 140°
Camera Resolution	640 X 480
LED Floodlight output	8 PCS 1W Nichia High Power LED
Lumen output	1100
Time adjustment	30 seconds ~ 7 minutes
Lux adjustment	Dark - daylight
Transmitter signal technology	2.4G FHSS Technology
Transmitter output power	16dBm
Transmission Range	150m open field
Voltage	100-240V 50Hz/60Hz
Current drain	225±20mA
IP rating	IP55
Operating Temperature	-10°C ~ 40°C
Dimensions	160 x 176 x 260MM
Weight	1400g

GuardCam WF-SAR

Channels	4
Reception Range	150 meters in open field
Receiver Resolution	800 X 480
Maximum SD card size	32Gb
Receiver technology	2.4GHz FHSS Technology
Video Output	1.2±0.2Vp-p/75ohm
Operating Voltage	DC 5V / 1A
Current Consumption	250mA(max)
Operating Temperature	-10°C ~ 50°C
Dimensions	122 x 113 x 25 mm
Weight	335g

GuardCam WF-MR

Channels	4
Reception Range	150 meters in open field
Receiver Resolution	800 X 480
Screen size	7" Screen (16:9)
Maximum SD card size	32Gb
Receiver technology	2.4GHz FHSS Technology
Video Output	1.2±0.2Vp-p/75ohm
Operating Voltage	DC 5V / 1A
Current Consumption	860mA(max)
Operating Temperature	-10°C ~ 50°C
Video Output	1.2±0.2Vp-p/75ohm
Audio output	75±10dB
Dimension	200 x 122 x 26 mm
Weight	400g

Elite Security Products
Unit 7, Target Park, Shawbank Rd
Lakeside, Redditch B98 8YN



Telephone: 01527 515150
Fax: 01527 515143
email: info@espuk.com